

Pneumatic and solenoid valves complying with NAMUR norms (direct assembly). Valves are entirely made in aluminium, to improve the solidity and the durability. Available size is 1/4 and available functions are 3/2 and 5/2.

La valve pneumatique et électrique a un plan de pose Namur (norme pour assemblage direct) est en aluminium, ce qui renforce sa robustesse et sa fiabilité. Elle est disponible en 1/4 fonction 3/2 et 5/2.

Valvole ad azionamento pneumatico ed elettrico con posa di montaggio diretta NAMUR. Costruzione interamente in alluminio per aumentare la robustezza e la durata nel tempo. Disponibili nella taglia 1/4 e nelle funzioni 3/2 e 5/2.

TECHNICAL DATA / DONNÉES TECHNIQUES / DATI TECNICI

Flow rate 6 bar Δp 1 bar / Debit à 6 bar Δp 1 bar / Portata a 6 bar Δp 1 bar	1100 NI/min
Nominal orifice / Diamètre nominal / Diametro nominale	7.5mm
Response time pneumatic / Temps de réponse pneu. / Tempi di risposta pneumatico	
• monostable / monostable / monostabile	TRA 7ms / TRR 15ms
• bistable / bistable / bistabile	TRA 7ms / TRR 7ms
Response time solenoid / Temps de réponse elect. / Tempi di risposta elettrico	
• monostable / monostable / monostabile	TRA 19ms / TRR 45ms
• bistable / bistable / bistabile	TRA 22ms / TRR 22ms
Pressure range / Pression d'utilisation / Pressione di esercizio	
• monostable / monostable / monostabile	2.5 ÷ 10bar
• bistable / bistable / bistabile	1 ÷ 10bar
Temperature range / Température d'utilisation / Temperatura di esercizio	-10°C / +60°C

ORDERING CODE / CODIFICATION / CHIAVE DI CODIFICA

V U 4 5 E L M 0 0 - T

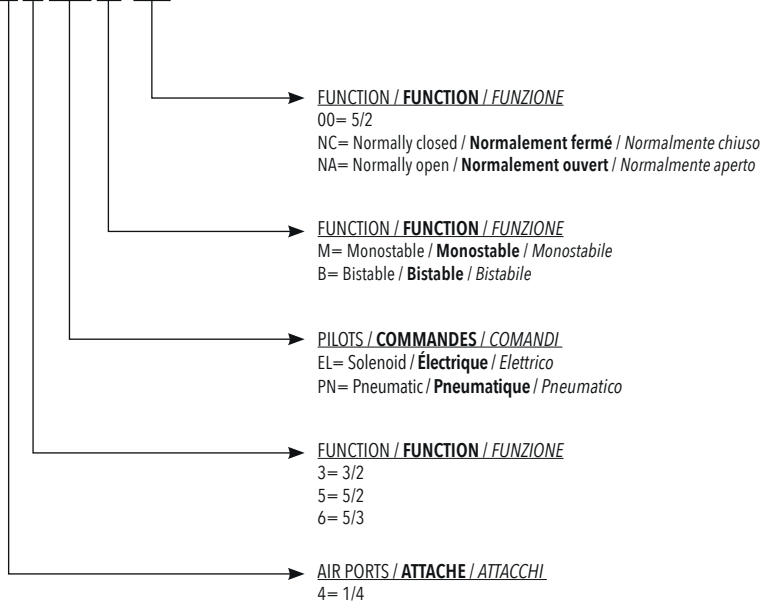

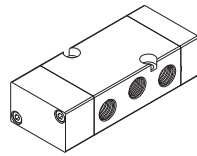
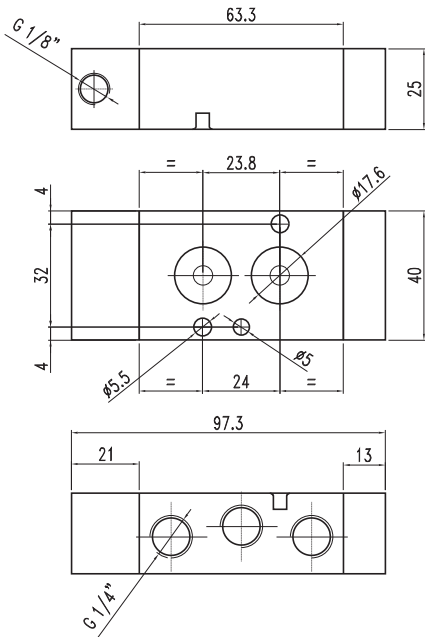

1/4 - 3/2 NC pneumatic pilot monostable
1/4 - 3/2 NF commande pneumatique monostable
 1/4 - 3/2 NC comando pneumatico monostabile

CODE
VU43PNMNC-T

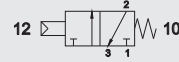

1/4 - 5/2 pneumatic pilot monostable
1/4 - 5/2 commande pneumatique monostable
 1/4 - 5/2 comando pneumatico monostabile

CODE
VU45PNM00-T

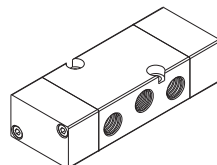
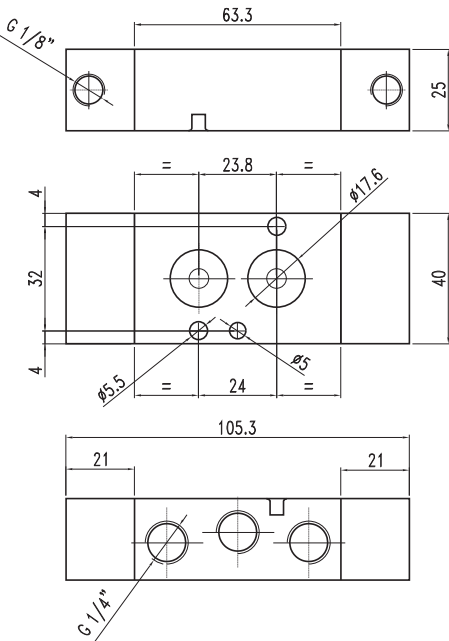
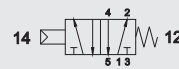

1/4 - 3/2 pneumatic pilot bistable
1/4 - 3/2 commande pneumatique bistable
 1/4 - 3/2 comando pneumatico bistabile

CODE
VU43PNB00-T

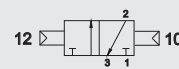

1/4 - 5/2 pneumatic pilot bistable
1/4 - 5/2 commande pneumatique bistable
 1/4 - 5/2 comando pneumatico bistabile

CODE
VU45PNB00-T



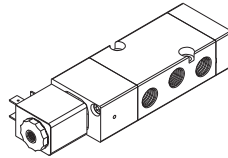
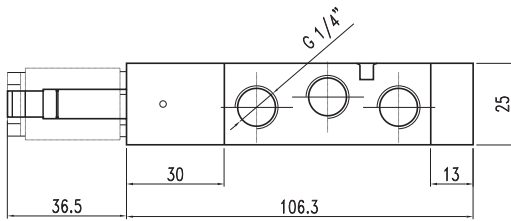
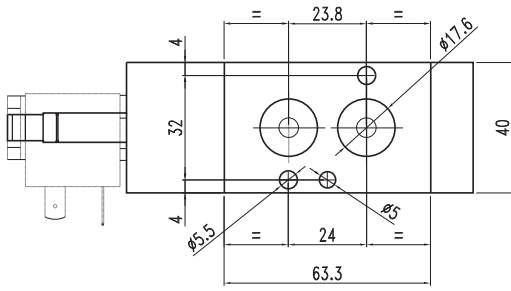

1/4 - 3/2 NC solenoid pilot monostable
1/4 - 3/2 NF commande électrique monostable
 1/4 - 3/2 NC comando elettrico monostabile

CODE
VU43ELMNC-T

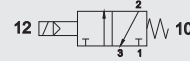

1/4 - 5/2 solenoid pilot monostable
1/4 - 5/2 commande électrique monostable
 1/4 - 5/2 comando elettrico monostabile

CODE
VU45ELM00-T

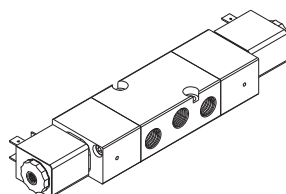
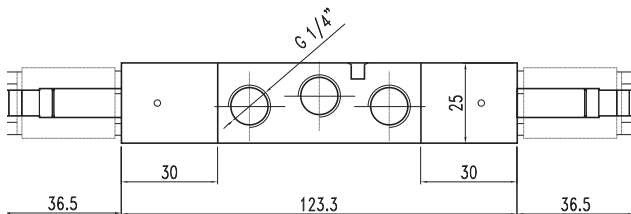
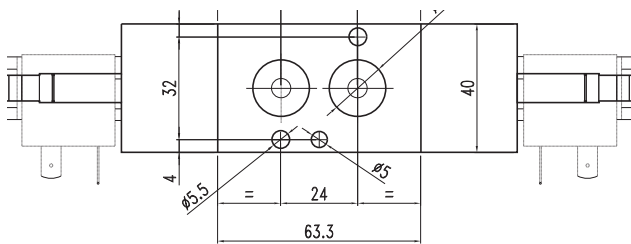
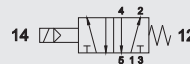

1/4 - 3/2 solenoid pilot bistable
1/4 - 3/2 commande électrique bistable
 1/4 - 3/2 comando elettrico bistabile

CODE
VU43ELB00-T

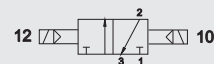

1/4 - 5/2 solenoid pilot bistable
1/4 - 5/2 commande électrique bistable
 1/4 - 5/2 comando elettrico bistabile

CODE
VU45ELB00-T

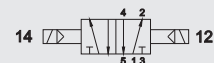

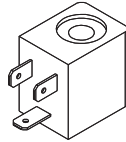
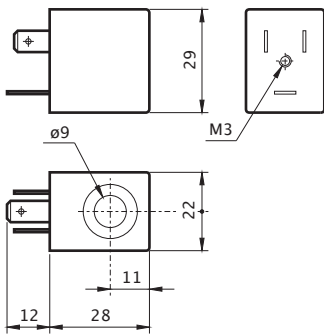

COILS
BOBINE
 BOBINE

POWER / ABSORPTION / ASSORBIMENTO

CODE	Tension Tension Tensione	Rated Résistance a regime	Inrush De sortie di spunto
B04011012	12 VDC	3W	
B04011024	24 VDC	3W	
B04012024	24 VAC	5VA	7,5VA
B04012110	110 VAC	5VA	7,5VA
B04012220	220 VAC	5VA	7,5VA

TECHNICAL SPECIFICATIONS
CARACTERISTIQUES TECHNIQUES
 CARATTERISTICHE TECNICHE

Tension tolerance / Tolérance / Tolleranza di tensione	+10%
Protection with connector / Protection avec connecteur / Protezione con connettore	IP65
Max working temperature / Température max d'utilisation / Temperatura max di esercizio	+ 50°C
Duty cycle / Temps d'enclenchement / Inserimento	ED 100%

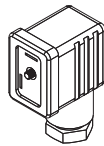
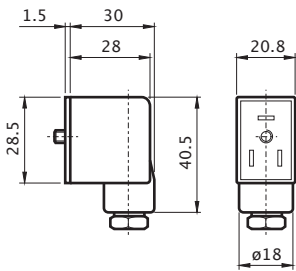

CONNECTORS
CONNECTEURS
 CONNETTORI

CODE	DES.
AR40696	STANDARD
VX0014	LED 24V
VX0015	LED 110V
VX0016	LED 220V
VX0017	LED+VDR 24V
VX0018	LED+VDR 110V
VX0019	LED+VDR 220V